

INSTALLATION MANUAL

AIR CONDITIONER

Please read this installation manual completely before installing the product.
Installation work must be performed in accordance with the national wiring standards by authorized personnel only.
Please retain this installation manual for future reference after reading it thoroughly.

Points Dry Contact (For Setback)

V-NET

PDRYCB400



P/NO : MFL69265519

www.lg.com

TABLE OF CONTENTS

■ Safety Precautions.....	3~5
■ Part Description.....	6
Installation.....	7
■ Setting and using method.....	9~16
1. Power supply and indoor unit connection.....	9
2. Setting of Contact Signal Input.....	10
3. Setting the desired temperature.....	11
4. Control mode setting.....	12
5. Indoor unit monitoring.....	16
■ Environmental information.....	17~18

Safety Precautions



To prevent injury to the user or other people and property damage, the following instructions must be followed.

- Incorrect operation due to ignoring instruction will cause harm or damage. The seriousness is classified by the following indications.

⚠ WARNING This symbol indicates the possibility of death or serious injury.

⚠ CAUTION This symbol indicates the possibility of injury or damage.

- Meanings of symbols used in this manual are as shown below.

	Be sure not to do.
	Be sure to follow the instruction.

⚠ WARNING

■ Installation

Don't touch with the hands while the power is on.

- Cause fire, electric shock, explosion or injury.

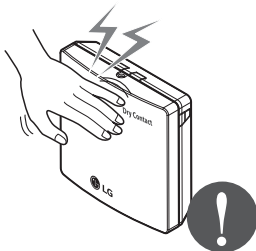

Product installation must be referred to a service center or installation shop.

- Cause fire, electric shock, explosion or injury.

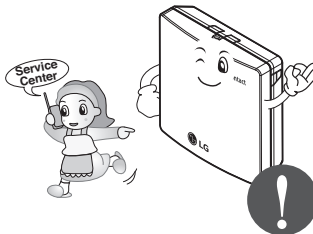

Request installation from installation shop or service center when reinstalling the product.

- Cause fire, electric shock, explosion or injury.



Do not install the product in the place where rain can get to the product.

- Cause product failure

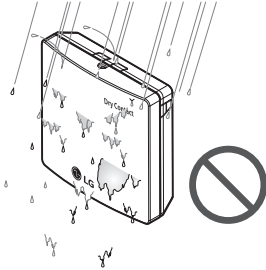

Do not install the unit in humid locations.

- Cause product failure

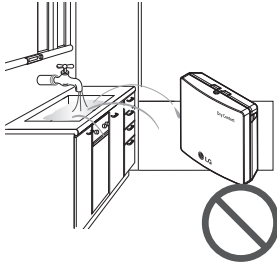

Do not put the product closer to fire.

- Cause fire

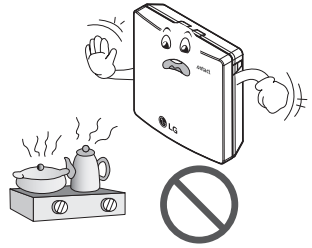

Do not install in a place that cannot withstand the weight of the product.

- The product may get damaged or may break.

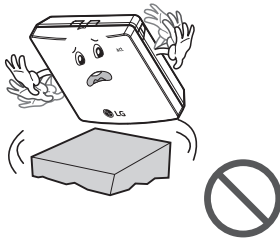

Do not install the product to a place that generates oil, steam, salt, sulfuric gas, etc.

- Cause the product's deformation or failure.

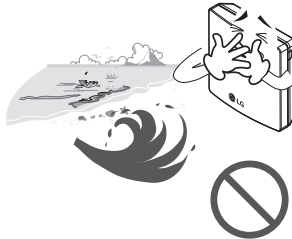

Use standardized Product.

- Cause product failure



■ Operation

Do not change or extend power lines arbitrarily.

- Cause fire or electric shock.

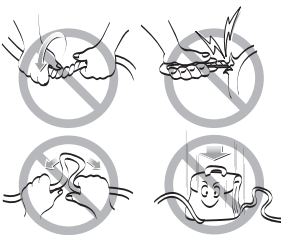

Do not give a shock to the product.

- If you give a shock to the product, it may cause the product's failure.

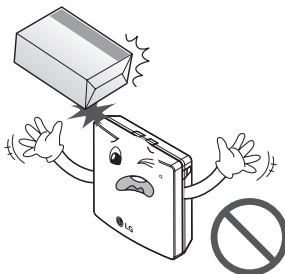

Do not use a heater near the power line.

- Cause fire or electric shock.

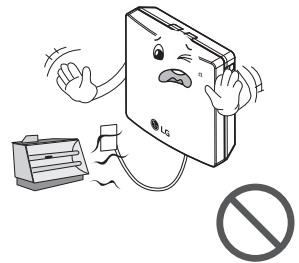

Do not spill water inside of the product.

- Cause electric shock or breakdown.

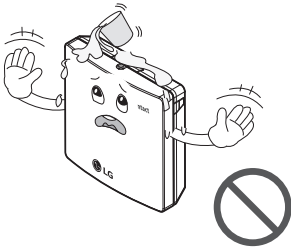

If the product has been in-dated, you must refer to a service center or installation shop.

- It can cause a fire.



Children and elderly use the product under the guardian's supervision.

- Cause accidents and product failures.

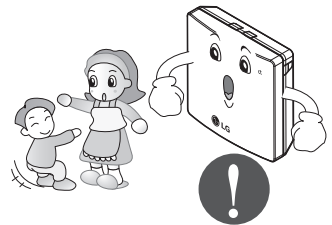

Do not use for special purpose / place such as conserving flora and fauna, precision instruments, art.

- Otherwise, it can cause property damage.

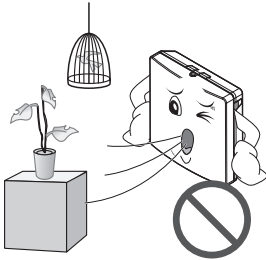

Remove the power plug when cleaning.

- Cause fire or electric shock.

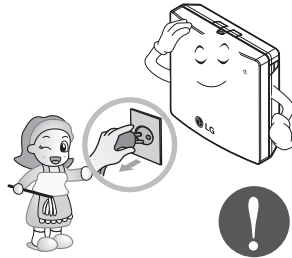

Do not place heavy objects on the power line.

- Cause fire or electric shock.

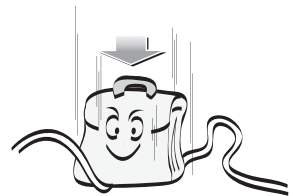

Do not disassemble, repair, or modify the product.

- Cause fire or electric shock.

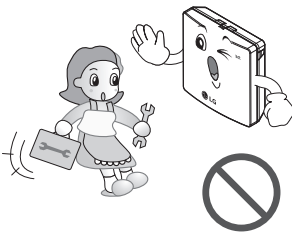

Do not touch with wet hands.

- Cause fire or electric shock.



Part Description



Front Case

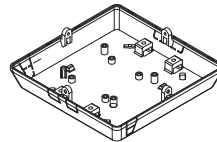

Rear Case

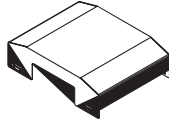

Metal Case (Front)

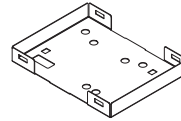

Metal Case (Rear)



Rubber

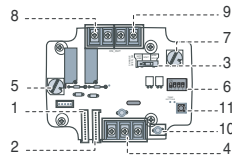

PCBA

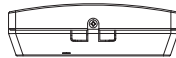

Side

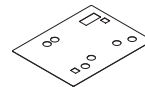

Isolation Sheet



Cable 1EA
(for connecting with indoor unit)

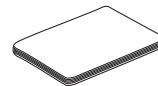

User/Installation
Manual

*Other : Screw (For installation, 4EA)
*Other : Clamp (For installation, 4EA)

DRY CONTACT FOR SETBACK

- 1. **CN_INDOOR** : Connect communication wire between indoor unit and Dry Contact For Setback and supply power to Dry Contact For Setback
- 2. **CN_PI485** : PI485 connector
- 3. **CHANGE_OVER_SW** : Switch to select voltage (5V-12V) of contact point
- 4. **CN_CONTROL** : Contact point signal input
- 5. **CONTROL_MODE_SW** : Switch to select the control mode
- 6. **SETTING_SW** : Switch to select whether to use set function of Dry contact for setback
- 7. **TEMP_SETTING** : Switch to set the desired temperature of the indoor unit
- 8. **CN_OUT (O1, O2)** : Connector to show whether the indoor unit is operating
- 9. **CN_OUT (E3, E4)** : Connector to show whether there is an error with the indoor unit
- 10. **DISPLAY_LED** : LED to display the status of the Dry Contact For Setback
- 11. **RESET_SW** : Reset switch

Installation

- 1) Loosen and remove two screws that secures the product.

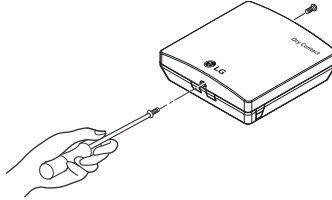

- 2) Remove the front metal case by pressing the marked points.

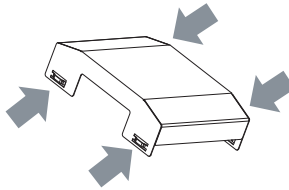

- 3) Position the rear case to the direction towards to the connector for convenient cable arrangement.

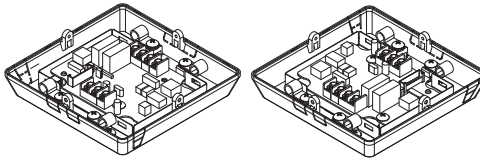

- 4) Remove 4 screws, for strapping wires.

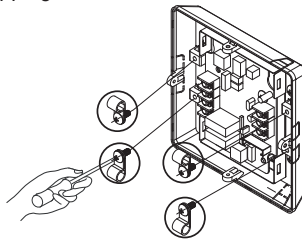

- 5) Secure the rear case on the installation place using the supplied fixing screws.

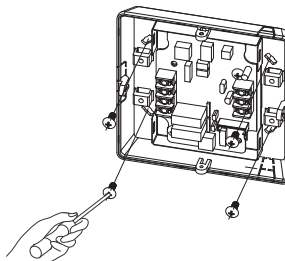

- 6) Remove knock out shapes on the rear case (2-sided) according to the connector's size and direction.

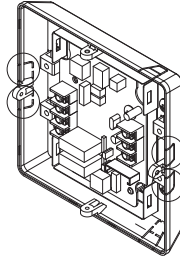

- 7) Connect the connection wires properly according to the connection method. (Refer to the instruction and set-up description)

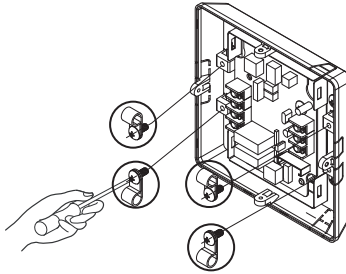

- 8) Set the switch according to the setting method. (Refer to the instruction and set-up description)
9) Hang the front of the case to the rear case hook and tighten the fixing screws on the bottom part.

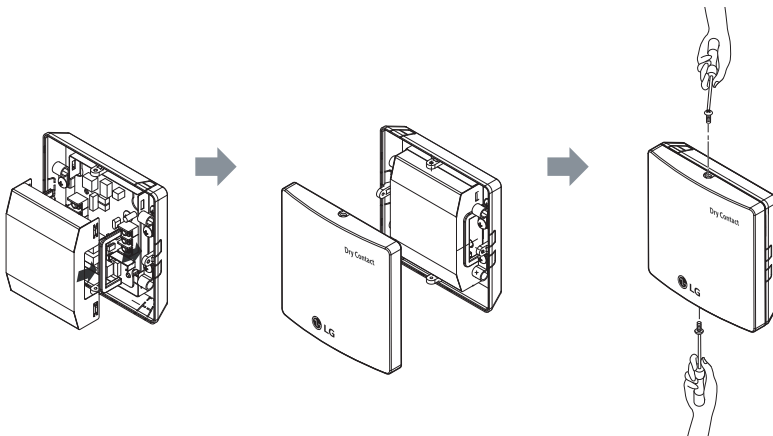

▲ CAUTION

1. Install the product on flat surface and install anchoring screws at more than 2 places. Otherwise the central controller may not be anchored properly.
2. Do not tighten anchoring screws too tightly. It may cause deformation of the case.
3. Do not deform the case at random. It may cause malfunction of the controller.

Setting and using method

You must press the RESET switch when you are completed with all the settings to reflect the settings.

1. Power supply and indoor unit connection

■ When using the Dry Contact For Setback independently

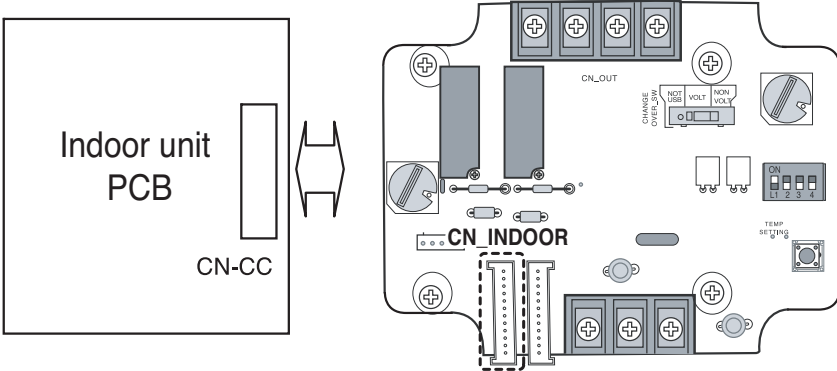

■ When using with the central controller (Only when the indoor unit PCB is a non-communication model)

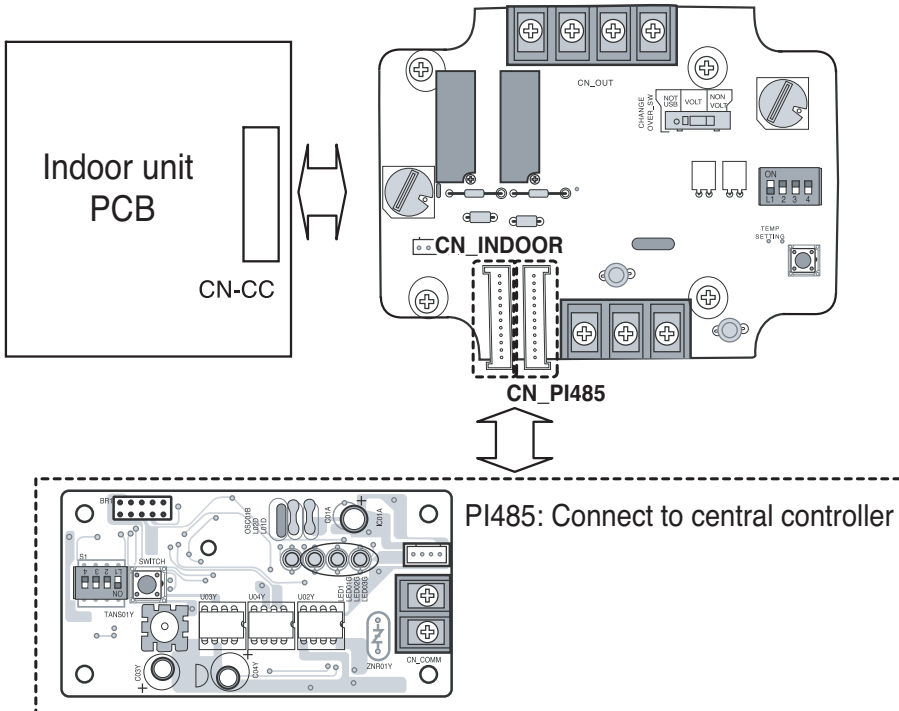

2. Setting of Contact Signal Input

■ For no power contact point signal input

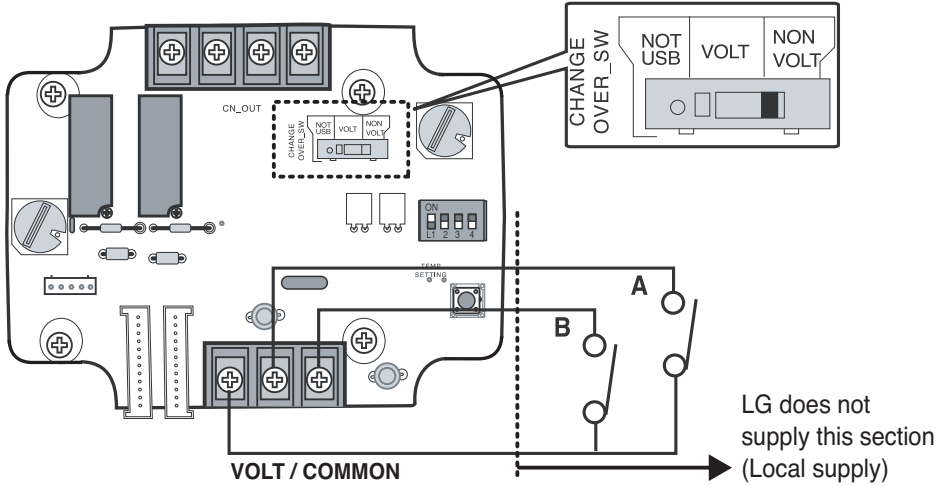

■ For power contact point signal input

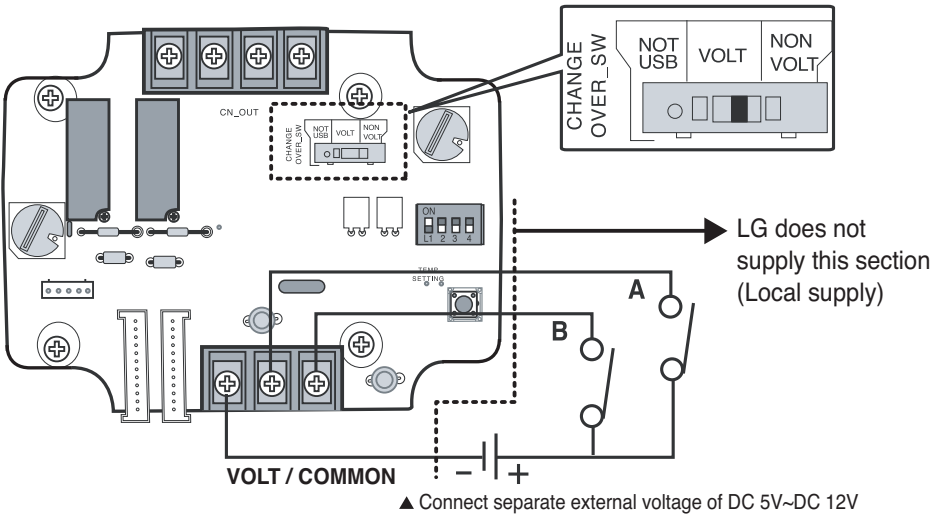

3. Setting the desired temperature

■ When setting the desired temperature of the Dry Contact For Setback

: When operating the indoor unit, set the desired temperature according to the TEMP_SW setting. When the indoor unit is unlocked, the desired temperature can be reset by other controller

1) Turn on the TEMP_SETTING switch of SETTING_SW.

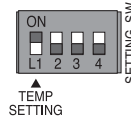

2) Use the TEMP_SW to set the temperature as shown below.

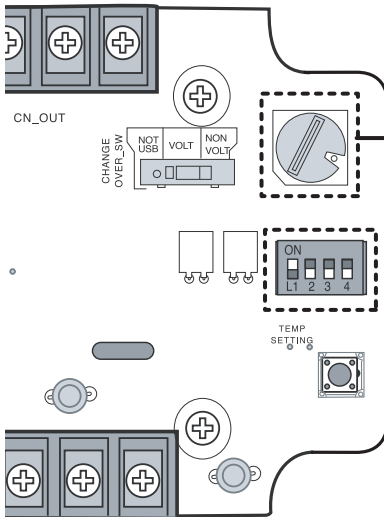

Desired temperature setting table

TEMP SW setting	0	1	2	3	4	5	6	7
Temperature setting(°C)	18	19	20	21	22	23	24	25
TEMP SW setting	8	9	A	B	C	D	E	F
Temperature setting(°C)	26	27	28	29	30	30	30	30

■ When not using the desired temperature setting of Dry Contact For Setback

1) Turn off the TEMP_SETTING switch of SETTING_SW.

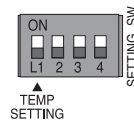

⤷ When operating the indoor unit initially with Dry Contact For Setback, set the desired temperature to 18°C.

4. Control mode setting

■ Use the CONTROL_MODE_SW to set the control mode you want from 0~E.

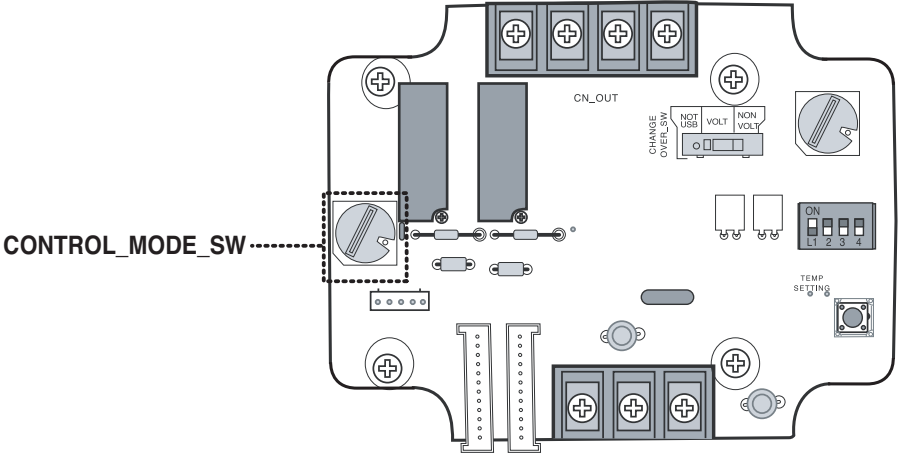

- ▷ Indoor control priority
Central control > Dry Contact For Setback > Wired/Wireless remote controller, indoor unit button
- ▷ Dry Contact For Setback controls the indoor unit according to the applicable mode when there is a change in input of A and B.

■ Description of each control mode

1) Cancel mode for use of Dry contact for setback

CONTROL_MODE SW	Input A	Input B	Operating mode
0	OFF	OFF	The indoor unit cannot be controlled through the Dry contact for setback No change in indoor unit condition
	ON	OFF	
	OFF	ON	
	ON	ON	

- ▷ Set this when the Dry Contact For Setback is connected but not used.

2) General mode

CONTROL_ MODE S/W	Input A	Input B	Operating mode
1	OFF	OFF	Indoor unit stopped, locked
	ON	OFF	Indoor unit prior operating condition maintained, unlocked
	OFF	ON	Indoor unit stopped, locked
	ON	ON	Indoor unit stopped, locked
2	OFF	OFF	Indoor unit stopped, locked
	ON	OFF	Indoor unit operating, unlocked
	OFF	ON	Indoor unit stopped, locked
	ON	ON	Indoor unit stopped, locked
3	OFF	OFF	Indoor unit stopped, locked
	ON	OFF	Indoor unit stopped, locked
	OFF	ON	Indoor unit prior operating condition maintained, unlocked
	ON	ON	Indoor unit operating, unlocked
4	OFF	OFF	Indoor unit stopped, locked
	ON	OFF	Indoor unit stopped, locked
	OFF	ON	Indoor unit prior operating condition maintained, unlocked
	ON	ON	Indoor unit prior operating condition maintained, unlocked
5	OFF	OFF	Indoor unit prior operating condition maintained, locked
	ON	OFF	Indoor unit prior operating condition maintained, locked
	OFF	ON	Indoor unit prior operating condition maintained, locked
	ON	ON	Indoor unit prior operating condition maintained, unlocked
6	OFF	OFF	Indoor unit prior operating condition maintained, locked
	ON	OFF	Indoor unit prior operating condition maintained, locked
	OFF	ON	Indoor unit prior operating condition maintained, locked
	ON	ON	Indoor unit operating, unlocked

3) Fan level setting mode

CONTROL_ MODE S/W	Input A	Input B	Operating mode
7	OFF	OFF	Indoor unit operating at low level, locked
	ON	OFF	Indoor unit operating at low level, unlocked
	OFF	ON	Indoor unit stopped, locked
	ON	ON	Indoor unit stopped, locked
8	OFF	OFF	Indoor unit operating at low level, locked
	ON	OFF	Indoor unit operating at low level, unlocked
	OFF	ON	Indoor unit stopped, locked
	ON	ON	Indoor unit prior operating condition maintained, unlocked

↪ When the indoor unit is operating with a Dry Contact For Setback, the fan level can be changed by other controller when the fan level is set to low level and the indoor is in unlocked condition.

4) Power save mode

CONTROL_ MODE S/W	Input A	Input B	Operating mode
9	OFF	OFF	Indoor unit operating in power save mode, locked
	ON	OFF	Indoor unit operating in power save mode, unlocked
	OFF	ON	Indoor unit stopped, locked
	ON	ON	Indoor unit operating not in power save mode, unlocked
A	OFF	OFF	Indoor unit operating in power save mode, locked
	ON	OFF	Indoor unit operating in power save mode, unlocked
	OFF	ON	Indoor unit stopped, locked
	ON	ON	Indoor unit stopped, locked

↪ When setting 9, A mode, the TEMP_SETTING must always be set to ON.

↪ Power save mode: Adjust the set temperature to +3°C for cooling and -3°C for heating.

5) Compressor stop mode

CONTROL_ MODE S/W	Input A	Input B	Operating mode
B	OFF	OFF	Indoor unit operating (Compressor in stop mode), locked
	ON	OFF	Indoor unit prior operating condition maintained (Compressor not in stop mode), unlocked
	OFF	ON	Indoor unit stopped, locked
	ON	ON	Indoor unit stopped, locked

▷ Compressor stop mode: The compressor is stopped during cool/heat operation.

6) Operating mode selection mode

CONTROL_ MODE S/W	Input A	Input B	Operating mode
C	OFF	OFF	Indoor unit stopped, unlocked
	ON	OFF	Indoor unit in cool/high operation, unlocked
	OFF	ON	Indoor unit in heat/high operation, unlocked
	ON	ON	Indoor unit in fan/high operation, unlocked
D	OFF	OFF	Indoor unit stopped, locked
	ON	OFF	Indoor unit in cool/high operation, locked
	OFF	ON	Indoor unit in heat/high operation, locked
	ON	ON	Indoor unit in fan/high operation, locked

▷ Power save mode: Adjust the set temperature to +3°C for cooling and -3°C for heating.

7) Compressor stop mode when interlocking with Economizer

CONTROL_ MODE S/W	Input A	Input B	Operating mode
E	OFF	OFF	Indoor unit prior operating condition maintained (Compressor not in stop mode), unlocked
	ON	OFF	Indoor unit operating (Compressor in stop mode), unlocked
	OFF	ON	Indoor unit stopped, unlocked
	ON	ON	Indoor unit stopped, unlocked

▷ When interlocking with Economizer, turn On 2nd switch of SETTING.

5. Indoor unit monitoring

■ **Monitoring operation and error status : Refer to below and connect to the control device that you want to control.**

1) Turn Off the 2nd switch of SETTING_SW.

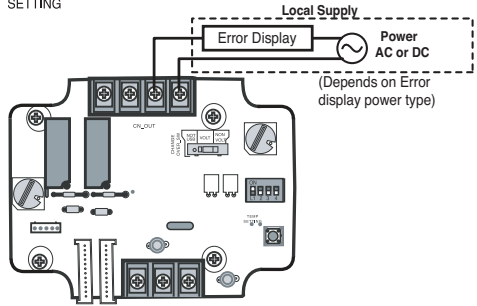
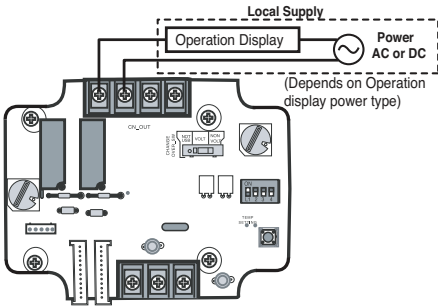
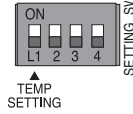

■ **Cooling, Thermal On Mode and Occupancy output : This relay output is for interlocking with economizer.**

1) Turn ON the 2nd switch of SETTING_SW.

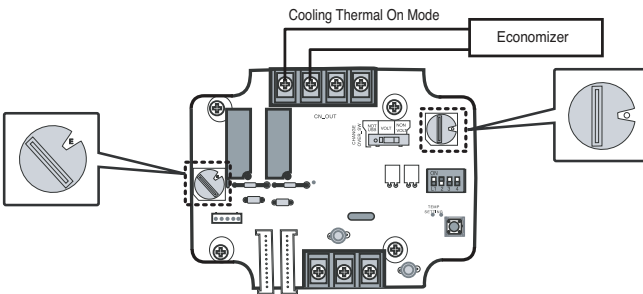
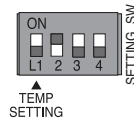

↳ When Indoor unit is operating as Cooling Thermal On Mode Relay output is closed.

Environmental information

Disposal of your old appliance(as per e-waste Rules)



1. When this crossed out wheeled bin symbol is depicted on the product and its operator's manual, it means the product is covered by the e-waste Management and Handling Rules , 2011 and are meant to be recycled, dismantled, refurbished or disposed off.

2. Dos

- a. The product is required to be handed over only to the authorized recycle for disposal.
- b. Keep the product in isolated area, after it becomes non-functional/un-repairable so as to prevent its accidental breakage.

Don't

- a. The product should not be opened by the user himself/herself, but only by authorized service personnel.
 - b. The product is not meant for re-sale to any unauthorized agencies/scrap dealer/kabariwalah.
 - c. The product is not meant for mixing into household waste stream.
 - d. Do not keep any replaced spare part(s) from the product in exposed area.
3. Any disposal through unauthorized agencies/person will attract action under Environment (Protection) Act 1986 .
 4. This product is complied with the requirement of Hazardous Substances as specified under Rule 13 (1) & (2) of the E-Waste (Management & Handling) Rules, 2011.
 5. To locate a nearest collection centre or call for pick-up (limited area only) for disposal of this appliance, please contact Toll Free No. **1800-180-9999** for details. All collection centre and pick up facilities are done by third parties with **LG Electronics India Pvt. Ltd.** Merely as a facilitator.
For more detailed information , please visit : <http://www.lge.com/in>.

अपने पुराने नपिटान के उपकरण (ई-अपशषिट नयिम के अनुसार)



1. जब इस काटे गए पहिये वाले बनि का चन्निह कसिी उपकरण और इसके ओपेरटर की पुस्तकि के साथ संलग्न होता है तो इसका मतलब है कि इसे "ई-अपशषिट" (प्रबंधन और हथालन) नयिम २०११ के अंतर्गत सम्मलिति कयिा गया है , और इसे नवीनीकरणकरन ,वघिटन और नपिटान के लपिए बनाया गया है ।
2. करें
क . उपकरण को सर्रिफ अधकृति पुनः नवीनीकरणकर्ता को ही नपितारण करने हेतु हस्तान्तरति करें ।
ख. जब उपकरण कार्रयरत न हो इसे अलग क्षेत्र में रखें ताक उपकरण से होने वाली दुर्घटनाओ से बचा जा सके ।
न करें
क. इस उपकरण को स्वयं/खुद नहीं खोलना चाहिए ! उपकरण को केवल अधकृति अधकिारी के द्वारा ही खोला जाना चाहिए ।
ख. इस उपकरण को पुनः बकिरी के लपिए कसिी भी कबाडीवाला / भंगार-वाला / अनाधकृति संस्था को न दें ।
ग. इस उपकरण को कसिी घरेलू अपशषिट सामान के साथ मलिकर न रखें ।
घ. उपकरण के बदले हुए या आंतरकि पुरजो को खुले क्षेत्र में न रखें ।
3. यदि कसिी अनाधकृति वभिग या व्यक्ती के द्वारा नपितारन कयिा जाता है तो यह पर्यावरण (सुरक्षा) धारा १९८६ के अंतर्गत आता है ।
4. यह उत्पाद खतरनाक पदार्थों के लपिए बनाये गए नयिमांक १३ (१) और (२), ई-वेस्ट (प्रबन्द्धन और रखरखाव) नयिम २०११ के कानून का पालन करता है.
5. उपरोक्त पदार्थो के नपितारन के लपिए नजदीकी नपितारन संसथान (संकीरण क्षेत्र)में काल करें। अधकि जानकारी के लपिए हमारे टोल फ्री नंबर **1800-180-9999** पर काल करें. सभी संग्रहण केंद्र व पकि-अप की सुवधिए कसिी थर्ड-पार्टी जो "LG Electronics India Pvt. Ltd." को अपनी सेवाएं प्रदान कर रही हों, से करवाएं ।
ज्यादा जानकारी के लपिए देखें वेब:साईट - <http://www.lge.com/in>

